

Real-time control prototyping of driver assistance and autonomous driving technologies at Mobileye

Patric Schenk, VP of Sales and Engineering, Speedgoat
12-May-2015



The EyeQ chip

- Performs interpretations of the visual field
- All object detection algorithms are conducted by a monocular camera, reducing costs and simplifying tooling and packaging of the camera sensor device
- As of today, Mobileye chips are used in over 5.2 million vehicles
- Until end of 2016, the chip will be used in 247 car models from 22 car manufacturers

www.mobileye.com



A Mobileye EyeQ2 chip used with a Hyundai lane guidance camera module



EyeQ3 chip accepting multiple cameras from surround-view systems

Leveraging the EyeQ chip and a real-time computer for autonomous driving

- All vision detection and processing tasks are performed by the EyeQ chip
- A rugged industrial real-time computer for in-vehicle use was required to:
 - ✓ Acquire processed vision data from the EyeQ chip, and speed, steering feedback, yaw rate, and other data from the vehicles buses via CAN
 - ✓ Run real-time controls applications created from Simulink, including the above communication protocol interface
 - ✓ Dynamically monitor and tune the real-time application during real-time runs
 - ✓ Log data during long-term standalone test runs for post execution analysis

Contents of delivery

Speedgoat hardware, drivers, and test models

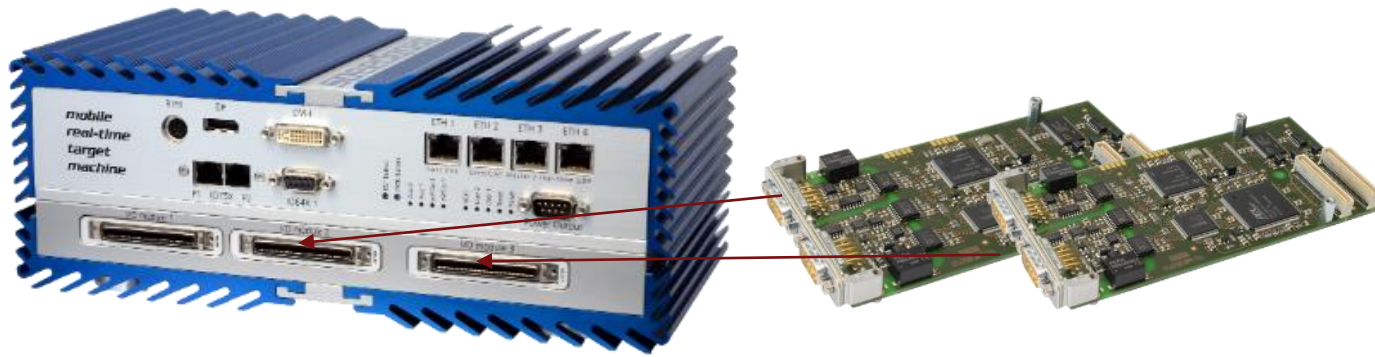

Mobile real-time target machine with 7x24 drive for data logging

2 x IO601 CAN I/O modules (4 ports)

MathWorks software

- MATLAB
- Simulink
- MATLAB Coder
- Simulink Coder
- Simulink Real-Time



I/O cables



Terminal boards

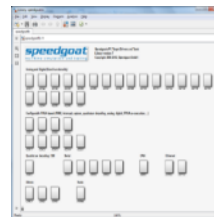

Driver blocks

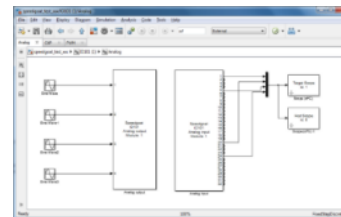

Simulink test models

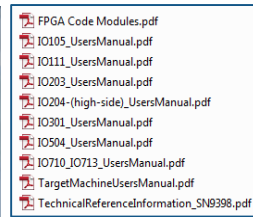

Documentation

Connection with EyeQ chip, and vehicle buses

- ✓ Drag & drop driver blocks for I/O modules installed in target machine to your model
- ✓ Connect I/O ports of driver blocks with your design

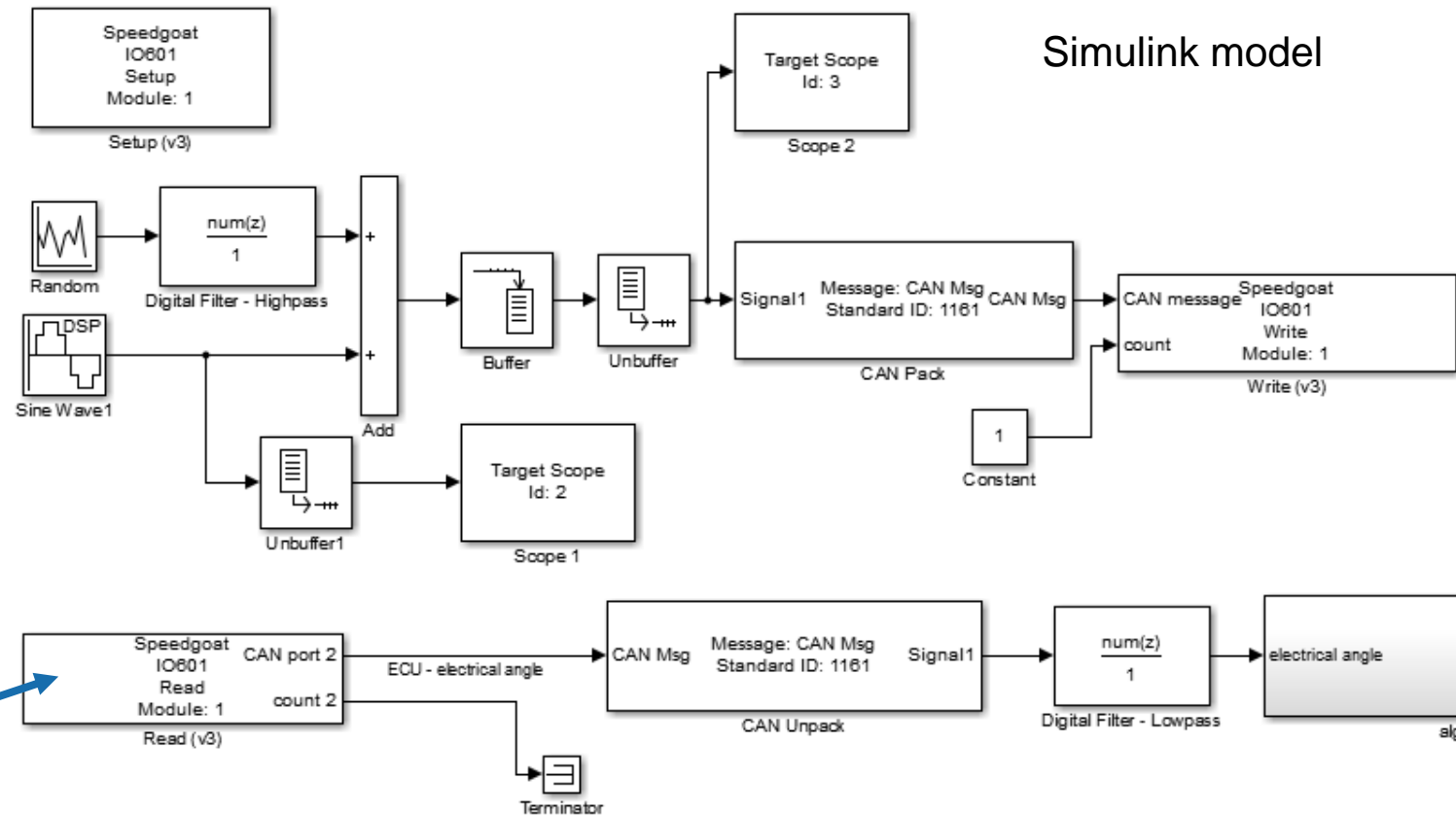
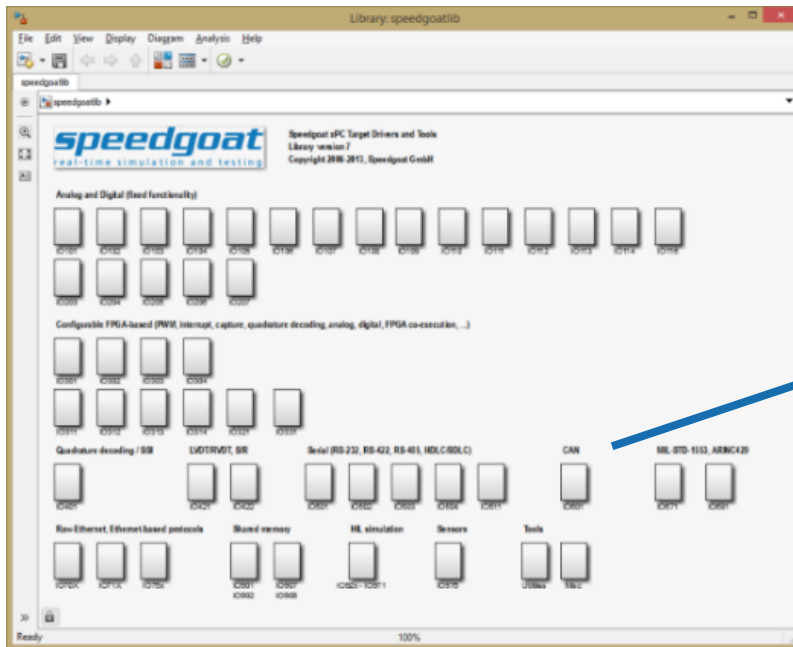

Speedgoat and Simulink Real-Time drivers

Connection with EyeQ chip, and vehicle buses

- ✓ Configure I/O and protocols settings through dialog fields
- ✓ Automatically create and run a real-time application from your Simulink model on the target machine

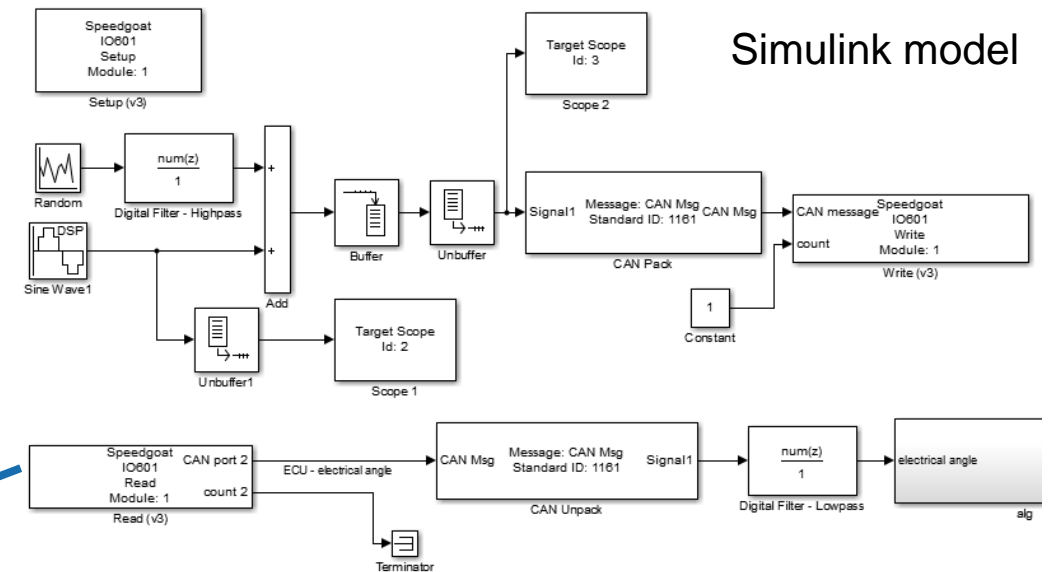

Simulink model

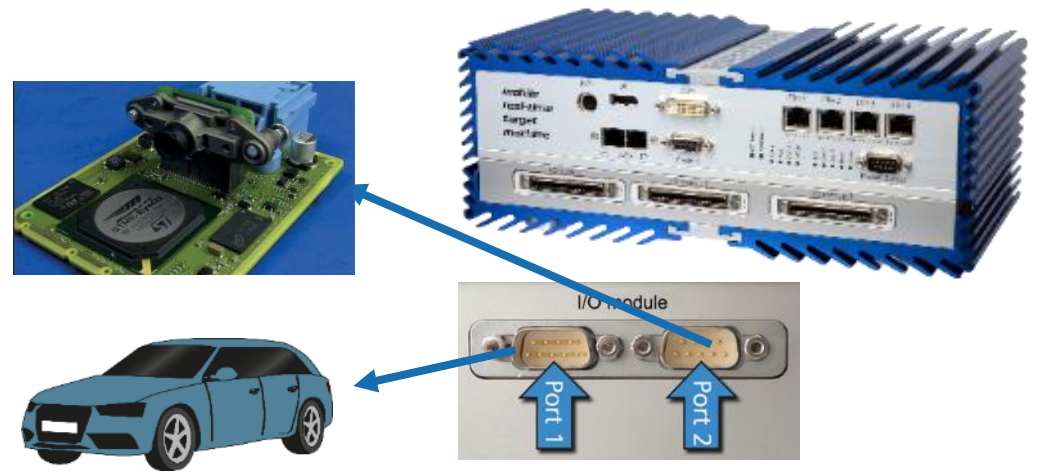
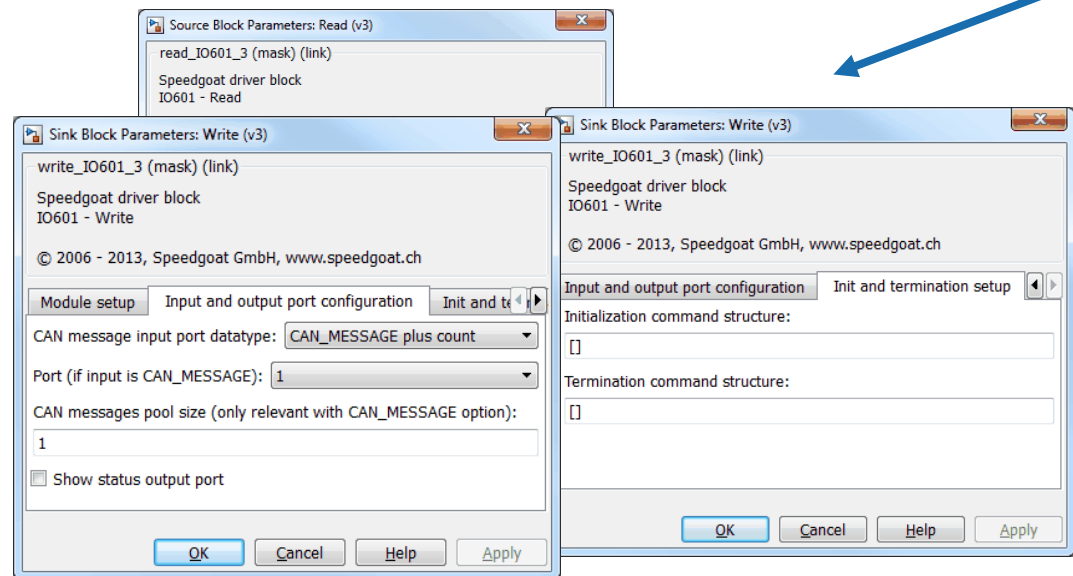

Application instrumentation with Simulink Real-Time

Simulink Real-Time Explorer

- Manage and control Real-time target machines and applications
- Rapidly build instrument panels (GUIs)
- Leverage panels to tune parameters in real-time

External mode

- Dynamically tune parameters directly in your Simulink model using external mode

Scopes

- Monitor signals on a screen attached to your target machine with target scopes
- Monitor signals using host scopes
- Log data on the target machine, for post real-time execution analysis, using file scopes



Stand-Alone Operation

- **Embed real-time applications**

Simple: Simply select standalone mode

Normal mode: Target machine is connected to development computer with Ethernet cable, application parameters are dynamically tunable during real-time runs

Standalone mode: Real-time application and real-time kernel are combined to a single executable. Applications starts at power-up of target machine

- **Standalone User Interfaces**

Run Simulink Real-Time Explorer in standalone mode, or leverage C or .NET APIs

- **Royalty Free**

One license, many target machines

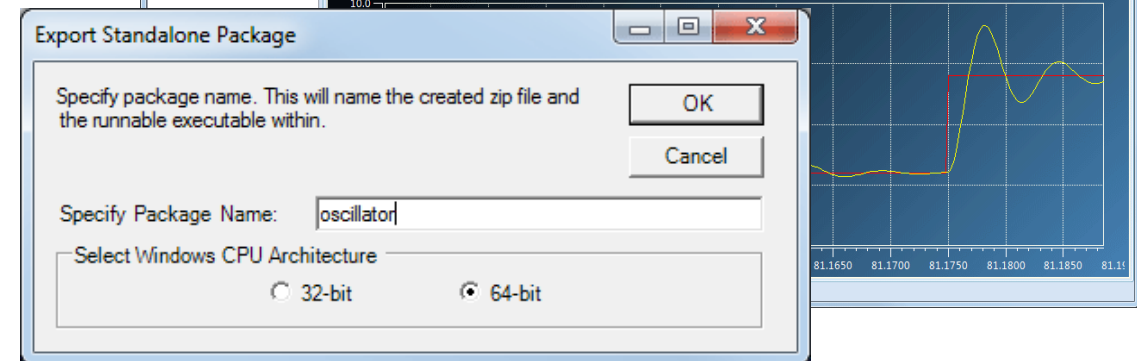
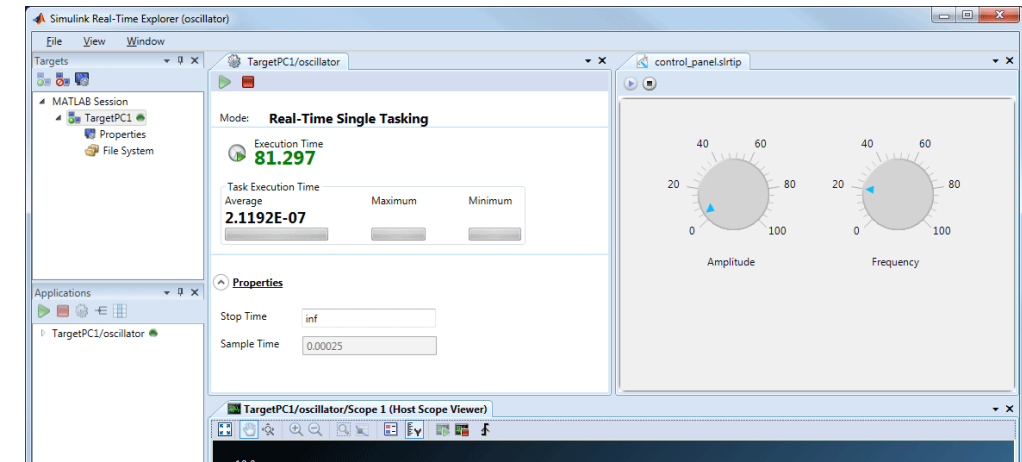
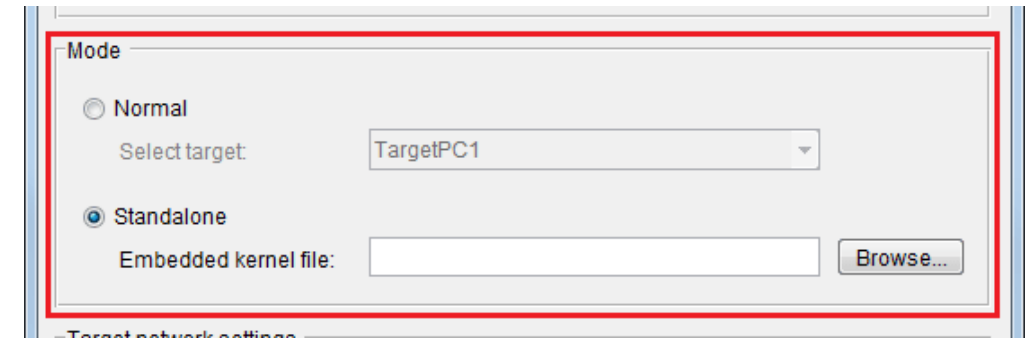

Value Contribution

“With the Speedgoat system, changing parameters and tuning the system is very easy and straightforward. It saves us a lot of time.”

“There is no need to re-compile and burn each new version of the control algorithm.”

Eyal Bagon
Senior Director Autonomous Vehicle
Mobileye



Eyal Bagon while **not driving** the car

User Story Examples - Developing Complex Products meeting Future Demands



Proterra, Greenville, SC, USA
Zero-Emission Battery Electric Bus
Hardware-in-the-Loop simulation



Levant Power, Woburn MA, USA
Energy neutral active suspension system
In-vehicle Rapid Controller Prototyping



AGCO, France/Germany/USA
Agricultural vehicles with most energy
efficient gearboxes
Hardware-in-the-loop simulation

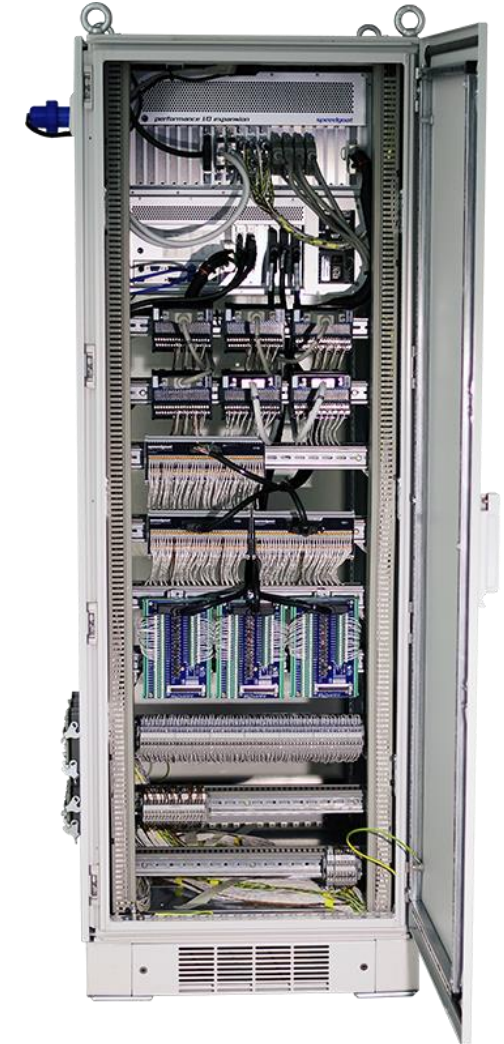

Resources and Contact Information



Meet us at our booth

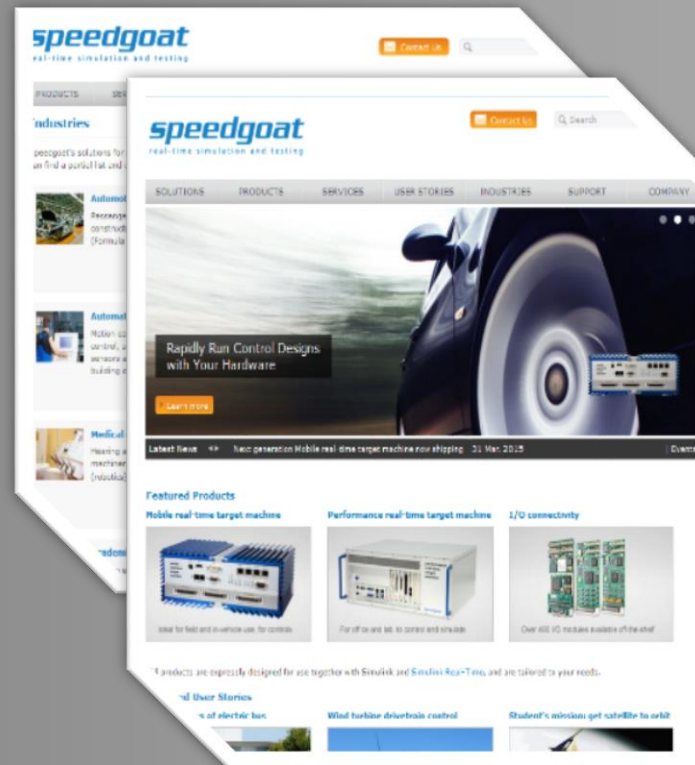

www.speedgoat.ch

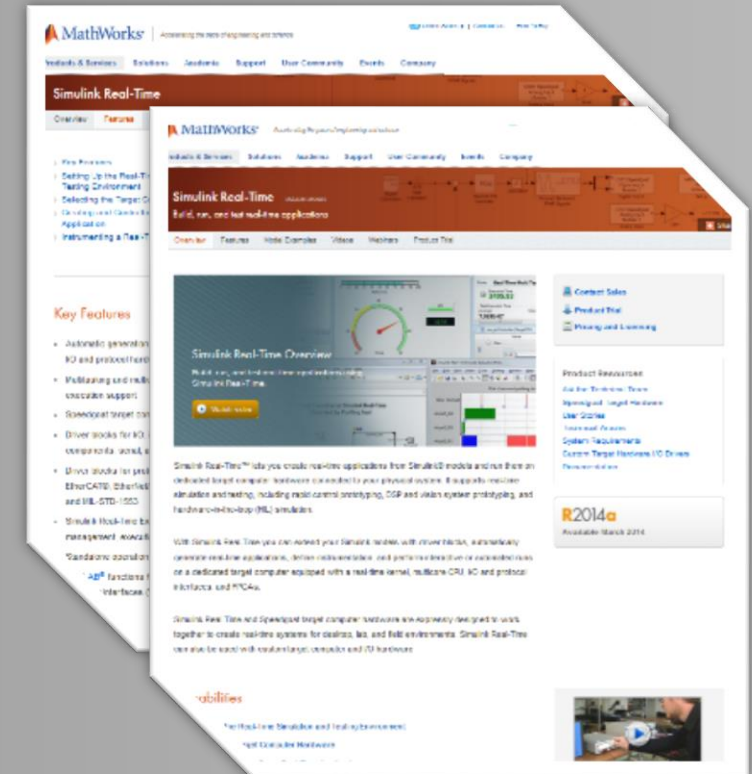

www.mathworks.com

Patric Schenk, patric.schenk@speedgoat.ch